

EXAMPLE 1

LED WALL

MODULAR

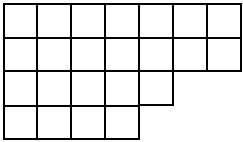

EXAMPLE 1
7X4 LED WALL
28 LEDS 50X50CM

H 2819



VW225 / VW226
ALUMINUM COLUMN
1800MM / 2700MM

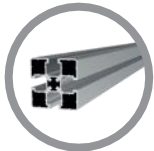

LW1000 / LW1500
ALUMINUM RAIL
1000MM / 1500MM



LW302 RAIL END CAP + LW303
AL RAIL EXTENSION BARS



LW301 LED
CONNECTION SET

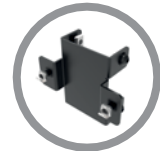

LW400 RAIL/COLUMN
CONNECTOR



VW228 LEG WITH ADJUSTABLE FEET
VW131 BRAKED WHEELS (OPTIONAL)

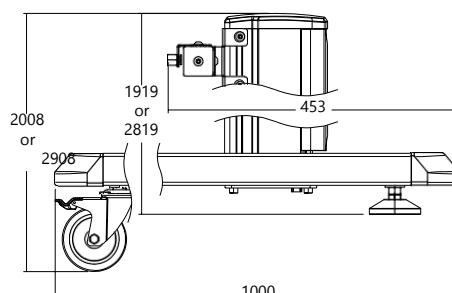

ALL DIMENSIONS (MM)

FREEDOM TO CREATE
MODULAR MOUNT
WITH **UNLIMITED**
CONFIGURATION

*
ALL PARTS &
COMPONENTS
PAGE 56-59

EXAMPLE 15

DISPLAY FLOOR MOUNT



VW202 AL RAIL 1500MM
END CAPS INCLUDED



CABLE CLIPS
INCLUDED



VW225 / VW226
ALUMINUM COLUMN
1800MM / 2700MM



VW218
RAIL / COLUMN
CONNECTOR

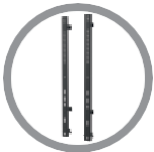

VW206
FIXED ARM 800MM



EASY TO INSTALL
AND COMBINE



ALL PARTS &
COMPONENTS
PAGE 58-59

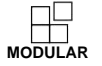

MODULAR

EXAMPLE 15
1 DISPLAY

65"-120"



VESÄ
200X200 to
1400X800



H 1919



150 MAX



VW228
LEG WITH
ADJUSTABLE FEET



VW131
BRAKED WHEELS
(OPTIONAL)

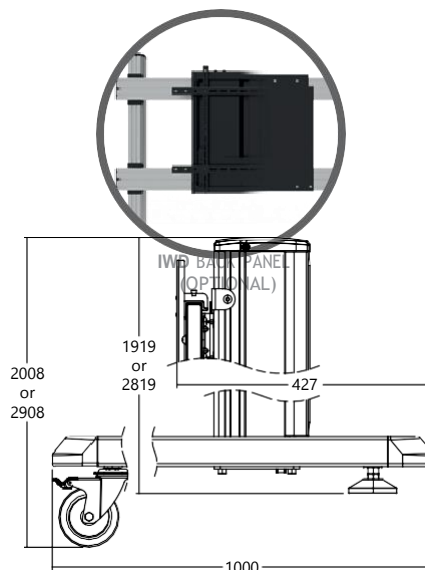

ALL DIMENSIONS (MM)

FREEDOM TO CREATE
MODULAR MOUNT
WITH UNLIMITED
CONFIGURATION

EXAMPLE 16

2X2 VIDEO WALL



EASY TO INSTALL
AND COMBINE

ALL PARTS &
COMPONENTS
PAGE 66-69

MODULAR

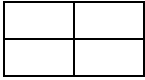

EXAMPLE 16
4 DISPLAYS
(2X2 VIDEO WALL)

50"-60"

VESA
200X200 to
600X400

H 1919



50 MAX
DISPLAY

EXAMPLE 17

3X3 VIDEO WALL



MODULAR

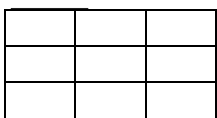

EXAMPLE 17
9 DISPLAYS
(3X3 VIDEO WALL)

55"-60"

VESA
200X200 to
600X400

H 2819



50 MAX
DISPLAY

EXAMPLE 18

DISPLAY FLOOR MOUNT

EXAMPLE 19

DISPLAY FLOOR MOUNT



MODULAR

EXAMPLE 18
1 DISPLAY

55"-98"



MODULAR

EXAMPLE 19
1 DISPLAY (TILT)

32"-75"



EXAMPLE 20

1X2 VIDEO WALL

FREEDOM TO CREATE
MODULAR MOUNT
WITH **UNLIMITED**
CONFIGURATION



EASY TO INSTALL
AND COMBINE

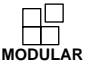

MODULAR

EXAMPLE 20
2 DISPLAYS
(1X2 VIDEO WALL)

40"-70"



FLOOR BOLTED MOUNTS

MOTORIZED SERIES

3
YRS
WARRANTY

MODULAR SERIES

3
YRS
WARRANTY

*CL600M FLOOR BOLTED MOUNT



CL400M

EAN: 5603209004951



RF REMOTE CONTROL INCLUDED



FOR FURNITURE INTEGRATION



32"-48"



ADJUSTABLE HEIGHT: 573-1238MM
COSTUMIZABLE POSITION MEMORY

CL600M

EAN: 5603209000489



50"-70"



ADJUSTABLE HEIGHT: 680-1580MM
COSTUMIZABLE POSITION MEMORY

FM1800B-M

EAN: 5603209000540



MOTORIZED MOUNT



RF REMOTE CONTROL INCLUDED



55"-100"



ADJUSTABLE HEIGHT: 925-1600MM
COSTUMIZABLE POSITION MEMORY

EXAMPLE N°2

LED WALL



MODULAR

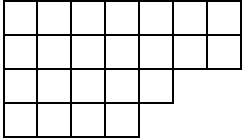

EXAMPLE 2
7X4 LED WALL
28 LEDS 50X50CM



H 2730



VW225 / VW226
ALUMINUM COLUMN
1800MM / 2700MM

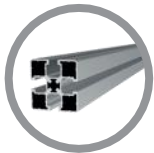

LW1000 / LW1500
ALUMINUM RAIL
1000MM / 1500MM

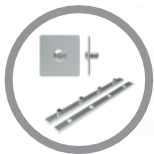

LW302 RAIL END CAP + LW303
AL RAIL EXTENSION BARS



LW301 LED
CONNECTION SET

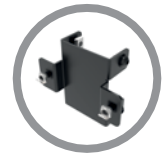

LW400 RAIL/COLUMN
CONNECTOR



VW220 BASE PLATE +
WALL SAFETY BRACKET

FREEDOM TO CREATE
MODULAR MOUNT
WITH **UNLIMITED**
CONFIGURATION

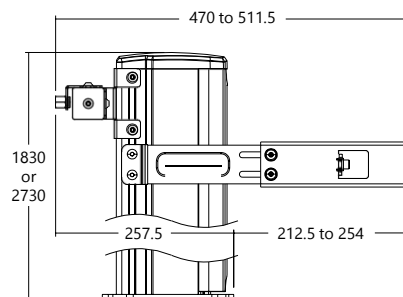

ALL DIMENSIONS (MM)



EXAMPLE 20

DISPLAY FLOOR MOUNT

FREEDOM TO CREATE
MODULAR MOUNT
WITH **UNLIMITED**
CONFIGURATION



EASY TO INSTALL
AND COMBINE

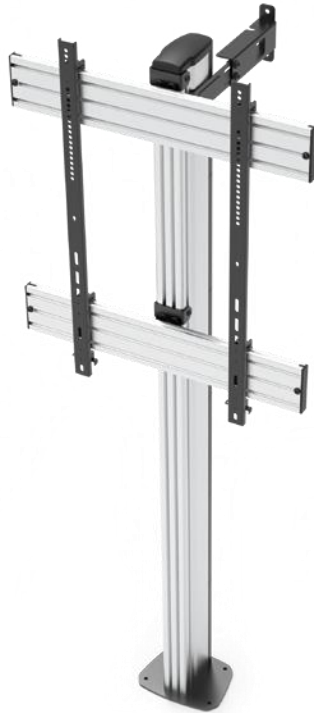

EXAMPLE 21
1 DISPLAY

55"-98"



EXAMPLE 29

DISPLAY FLOOR MOUNT



EXAMPLE 29
1 DISPLAY

55"-98"



EXAMPLE 30

DUAL DISPLAY BACK/BACK

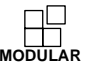

EXAMPLE 30
2 DISPLAYS
(DUAL DISPLAY BACK TO BACK)

55"-98"

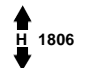

EXAMPLE 22

DISPLAY FLOOR MOUNT



MODULAR

EXAMPLE 22
1 DISPLAY (TILT)

32"-75"



EXAMPLE 25

2X1 MENU BOARD



MODULAR

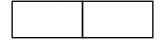

EXAMPLE 25
2 DISPLAYS
(2X1 TILT MENU BOARD)

43"-60"



EASY TO INSTALL
AND COMBINE



EXAMPLE 27

3X1 MENU BOARD

FREEDOM TO CREATE
MODULAR MOUNT
WITH **UNLIMITED**
CONFIGURATION



MODULAR

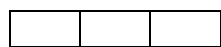

EXAMPLE 27
3 DISPLAYS
(3X1 TILT MENU BOARD)

50"-60"



EXAMPLE 23

1X2 VIDEO WALL



FREEDOM TO CREATE
MODULAR MOUNT
WITH **UNLIMITED**
CONFIGURATION



EASY TO INSTALL
AND COMBINE



MODULAR



EXAMPLE 23
2 DISPLAYS
(1X2 VIDEO WALL)

40"-70"



VESA
200X200 to
600X400



H 1830



50 MAX
DISPLAY

EXAMPLE 26

2X2 VIDEO WALL

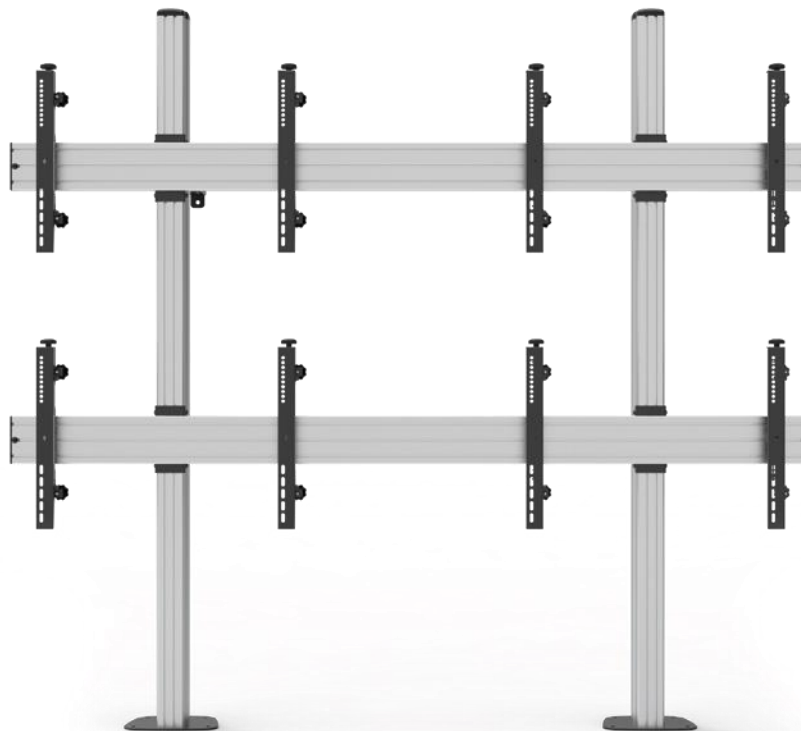

MODULAR

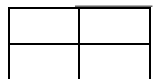

EXAMPLE 26
4 DISPLAYS
(2X2 VIDEO WALL)

50"-60"



VESA
200X200 to
600X400



H 1830



50 MAX
DISPLAY

EXAMPLE 24

1X3 VIDEO WALL



MODULAR



EXAMPLE 24
3 DISPLAYS
(1X3 VIDEO WALL)

40"-70"



FREEDOM TO CREATE
MODULAR MOUNT
WITH **UNLIMITED**
CONFIGURATION



EASY TO INSTALL
AND COMBINE



EXAMPLE 28

3X3 VIDEO WALL



MODULAR

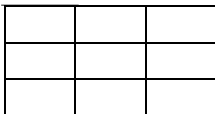

EXAMPLE 28
9 DISPLAYS
(3X3 VIDEO WALL)

55"-60"

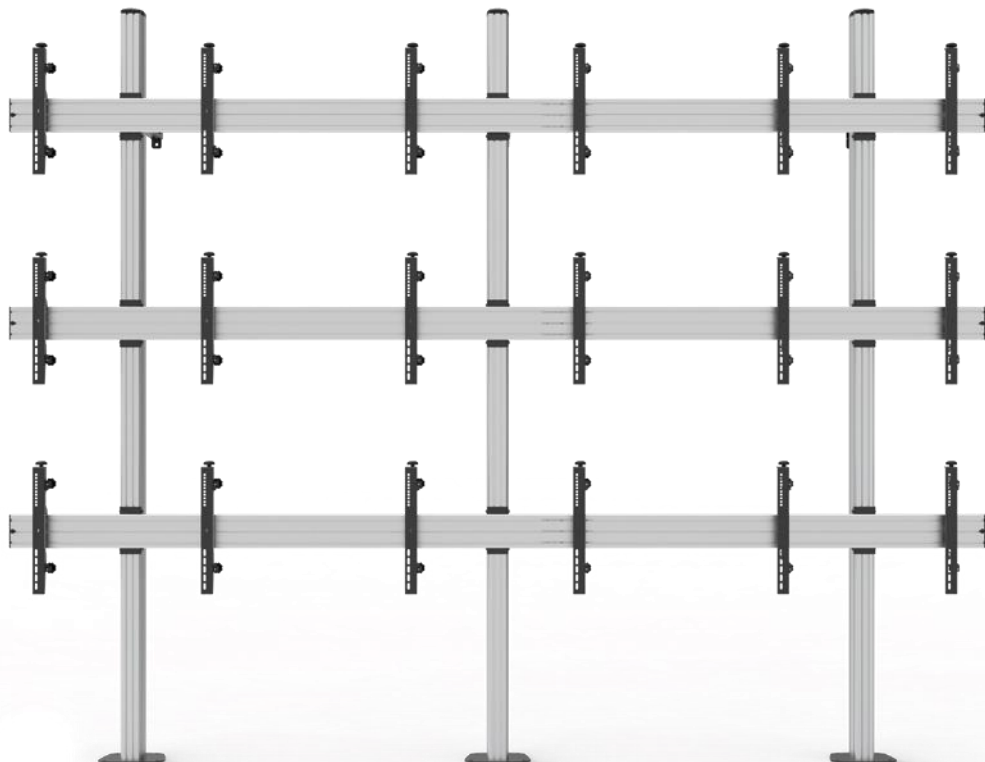

EXAMPLE 24

DISPLAY FLOOR MOUNT

EXAMPLE 34

2X1 MENU BOARD



EXAMPLE 31
1 DISPLAY (TILT)

32"-75"

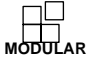

EXAMPLE 34
2 DISPLAYS
(2X1 TILT MENU BOARD)

43"-60"



FREEDOM TO CREATE
MODULAR MOUNT
WITH **UNLIMITED**
CONFIGURATION

EXAMPLE 37

3X1 MENU BOARD



EXAMPLE 37
3 DISPLAYS
(3X1 TILT MENU BOARD)

50"-60"



50 MAX
DISPLAY

EXAMPLE 32

DUAL DISPLAY BACK/BACK



MODULAR

EXAMPLE 32
2 DISPLAYS
(DUAL DISPLAY TILT
BACK TO BACK)

32"-75"

VESA
200X200 to
600X400

H 1806

kg
37.5 MAX
DISPLAY

EXAMPLE 35

DUAL 2X1 MENU BOARD BACK/BACK



MODULAR

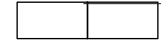

EXAMPLE 35
4 DISPLAYS
(DUAL 2X1 TILT MENU
BOARD BACK TO BACK)

43"-60"

VESA
200X200 to
600X400

H 1806

kg
37.5 MAX
DISPLAY

EXAMPLE 38

DUAL 3X1 MENU BOARD BACK/BACK



MODULAR



EXAMPLE 38
6 DISPLAYS
(DUAL 3X1 TILT MENU BOARD
BACK TO BACK)

50"-60"

VESA
200X200 to
600X400

H 1806

kg
37.5 MAX
DISPLAY



ALL PARTS &
COMPONENTS
PAGE 56-59



EASY TO INSTALL
AND COMBINE

EXAMPLE 33

1X2 VIDEO WALL



EXAMPLE 33
2 DISPLAYS
(1X2 VIDEO WALL)

40"-70"

VESA
200X200 to
600X400

H 1806

kg
50 MAX
DISPLAY

EXAMPLE 36

2X2 VIDEO WALL

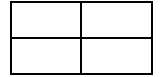
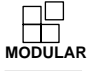

EXAMPLE 36
4 DISPLAYS
(2X2 VIDEO WALL)

50"-60"

VESA
200X200 to
600X400

H 1806

kg
50 MAX
DISPLAY



EASY TO INSTALL
AND COMBINE

FREEDOM TO CREATE
MODULAR MOUNT
WITH UNLIMITED
CONFIGURATION



EXAMPLE 39

3X2 VIDEO WALL

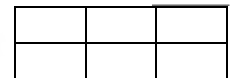
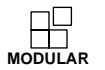

EXAMPLE N°26
6 DISPLAYS
(3X2 VIDEO WALL)

55"-60"

VESA
200X200 to
600X400

H 1806

kg
50 MAX
DISPLAY